

6.6 GHz Wi-Fi 6E Coexistence BAW Filter

A10266

Description

Akoustis' A10266 is a high-performance, ultra-wide bandwidth BAW RF Filter for use in Wi-Fi 6E applications covering portions of U-NII-5 thru U-NII-8 bands. A10266 utilizes Akoustis' patented, XBAW® technology which provides leading RF filter performance. This BAW RF filter provides low insertion loss and meets the stringent rejection requirements enabling coexistence with U-NII-1 thru 4. This device exhibits high-power handling capabilities necessary for demanding power requirements of the latest Wi-Fi 6E standards. A10266 is a fully integrated, 50Ω module using standard laminate packaging and is compatible with high volume, lead-free SMT soldering processes.

- Small form factor 3.5mm x 3.5mm x 1.73mm
- Single-ended Tx/Rx ports.
- Ultra-wide passband covering 1020 MHz
- High rejection enables coexistence with adjacent WiFi UNII bands
- High power rating, maximum +27 dBm
- Low insertion loss bandpass filter
- Performance over -40 C to +95C
- RoHS-compliant, Pb-free package

Applications

- Wi-Fi 6E tri-band routers, integrated cable modem
- Wi-Fi 6E tri-band access points
- LTE/LAA small cells

Functional Block Diagram

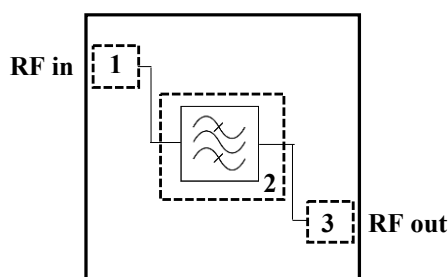

Pin #	Description
1	RF Input
2	Ground
3	RF Output

Ordering Information

Part Number	Description
A10266EVB	Evaluation board
A10266SP	(5) Loose pcs
A10266SR	(100) Short Reel (7" Reel)
A10266TR1	(1000) Tape & Reel (7" Reel)
A10266TR2	(2500) Tape & Reel (13" Reel)

Absolute Maximum Ratings

Parameter	Conditions	Rating
Storage Temperature		-40 to 125 °C
Input Power	Signal: OFDM MCS0, 20 MHz, PAR 10dB	+29 dBm
Max Temperature		-40 to 105 °C

Exceeding any one limit or a combination of AMR conditions may result in damage to the device

Operating Parameters (Temp = -20°C to +95°C unless otherwise noted)

Parameter	Conditions	Units	Min.	Typ.	Max.
Passband		MHz	6105	6615	7125
Insertion Loss	6105 – 7065 MHz	dB		2.4 ⁽¹⁾	3.2 ⁽²⁾
	7065 – 7125 MHz	dB			4.0 ⁽²⁾
Amplitude Variation	6105 – 7125 MHz	dB		1.6	1.6 ⁽²⁾
Attenuation	30 – 1000 MHz	dB	40	45	
	1000 – 2700 MHz	dB	25	30	
	3300 – 4200 MHz	dB	12	15	
	4200 – 4900 MHz	dB	5	8	
	5170 – 5895 MHz	dB	45 ⁽²⁾	51 ⁽²⁾	
	8500 – 12000 MHz	dB	15	20	
Return Loss	6105 – 7065 MHz	dB	9.6 ⁽²⁾	11 ⁽²⁾	
	7065 – 7125 MHz	dB	8.0 ⁽²⁾	8.5 ⁽²⁾	
Load Impedance		Ω		50	
Power Handling:	OFDM MCS0, 20 MHz, PAR 10dB	dBm			27

Note:

1. Averaged over specified frequency at room temperature.
2. Integrated over 160MHz channel.

EVB Schematic & Layout

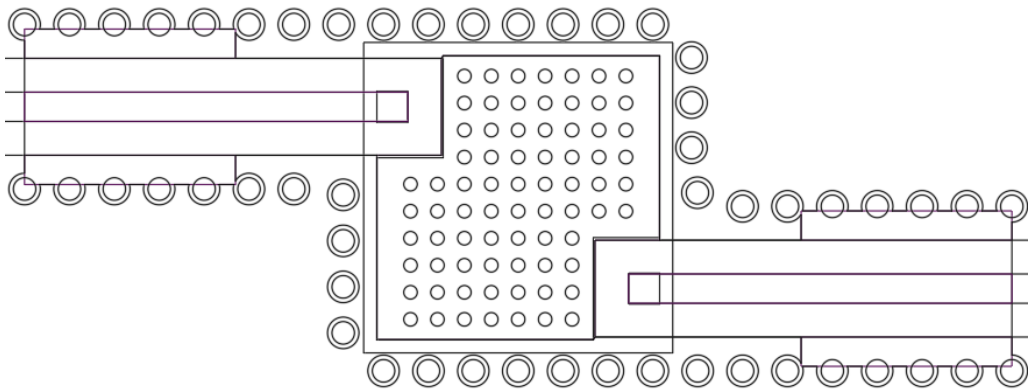
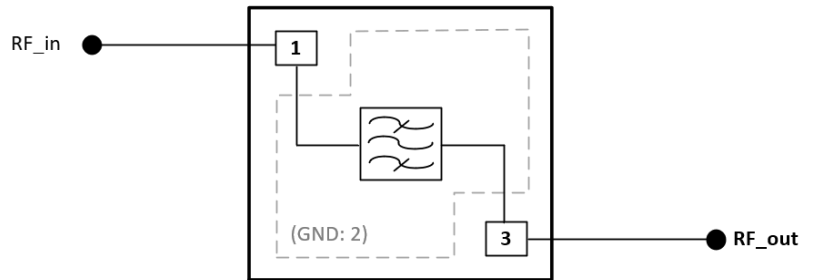
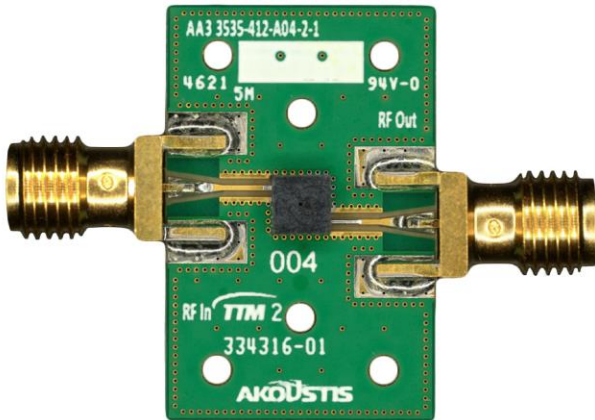

Note:

- 1) Center ground pad vias 6mil diameter
- 2) RF ground vias 10mil diameter

Bill of Materials

Reference Des.	Value	Description	Manufacturer	Part Number
PCB	N/A	4 layer	Multiple	AA33535-412-A04-2-1
U1	N/A	6.6 GHz BAW Filter	Akoustis	A10266

Performance Plots (Temp = 25°C unless otherwise noted)

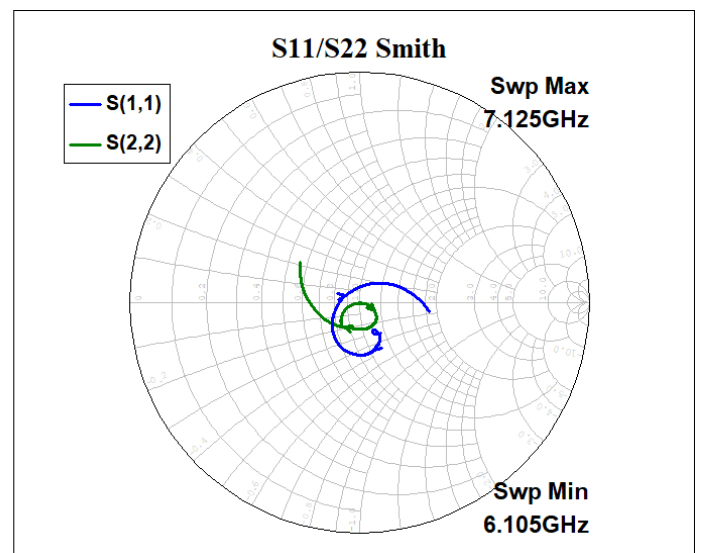
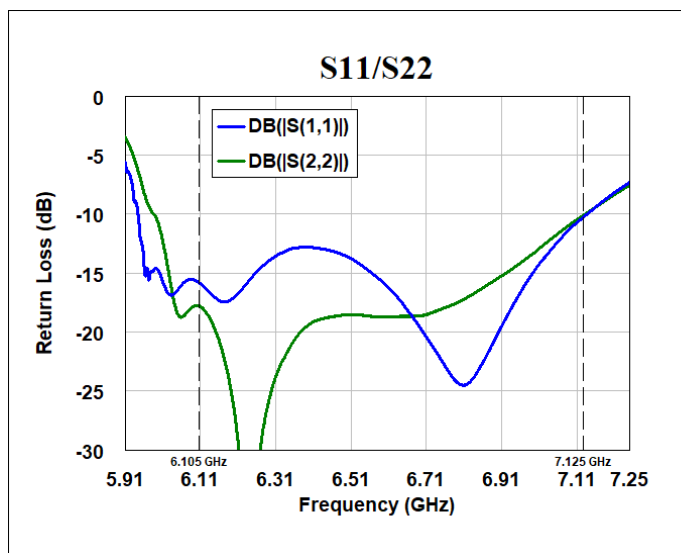
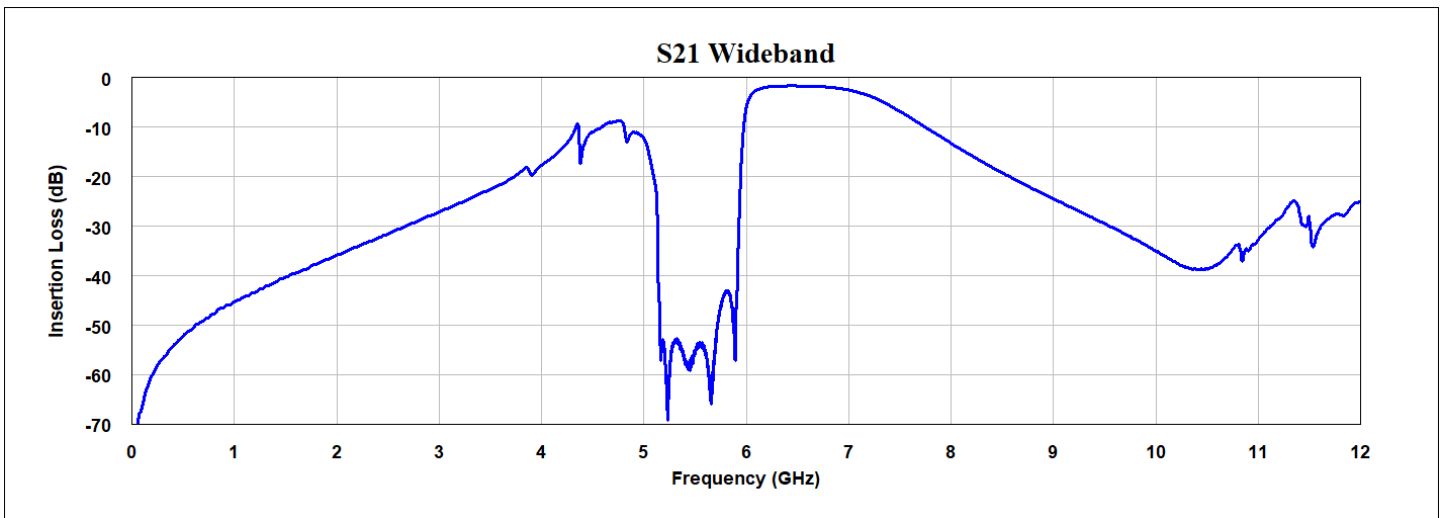
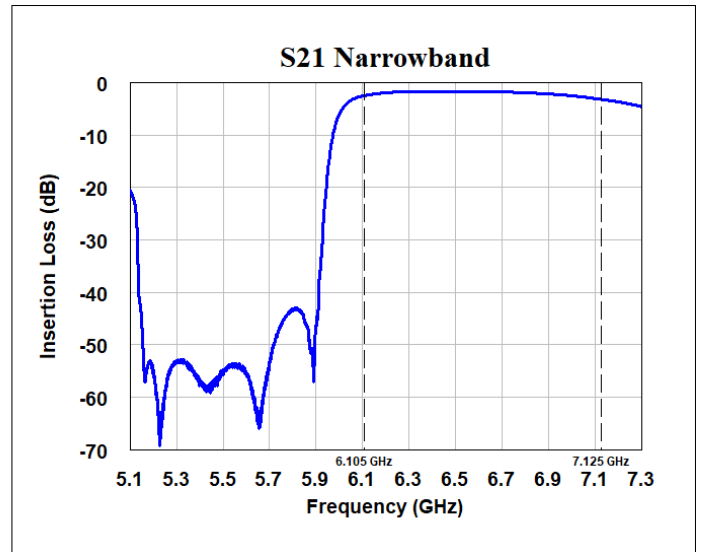
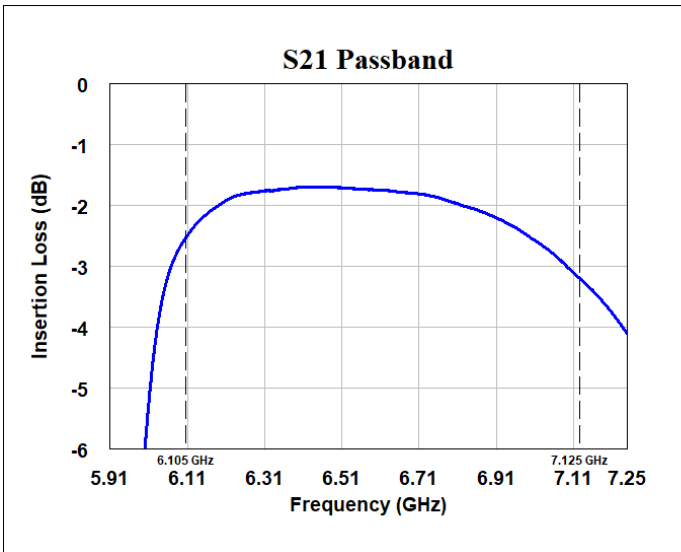

Package Drawing & Pin Description

- Notes:
- All Units are in mm unless otherwise stated
 - General Tolerance:
Linear X.XXX = $\pm 0.050\text{mm}$
X.XX = $\pm 0.10\text{mm}$
 - Terminal Finish:
Electroless Ni/Electroless Pd/Immersion Au

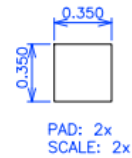
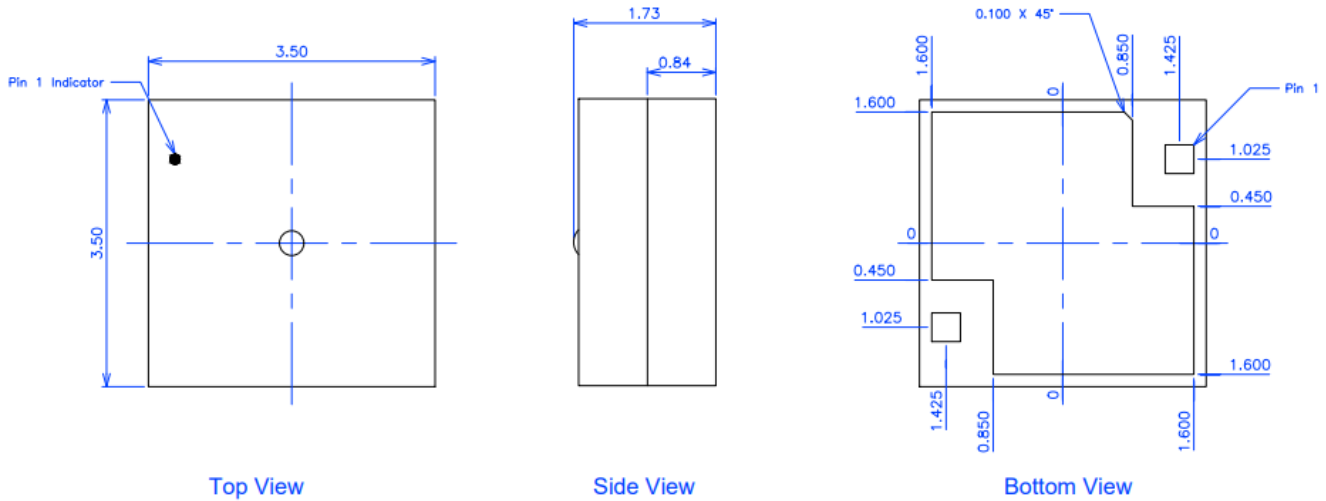

PCB Mounting Pattern

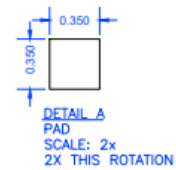
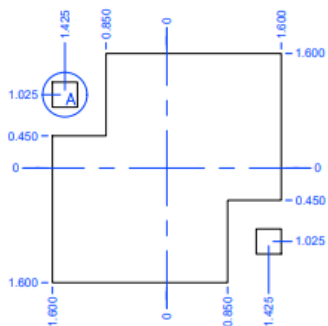

Recommended PCB Metal Top View

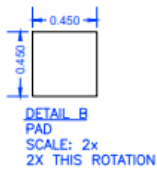
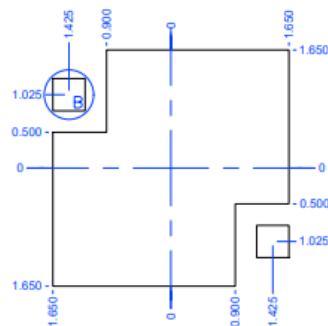

Recommended Solder Mask Opening Top View

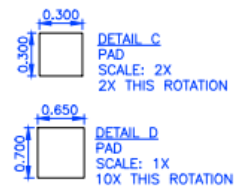
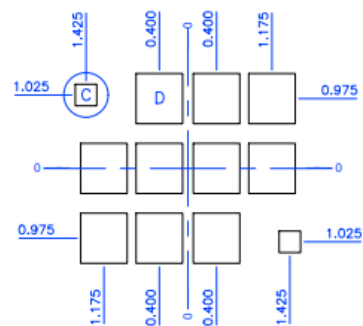

Recommended Stencil Pattern Top View

Typical Part Marking

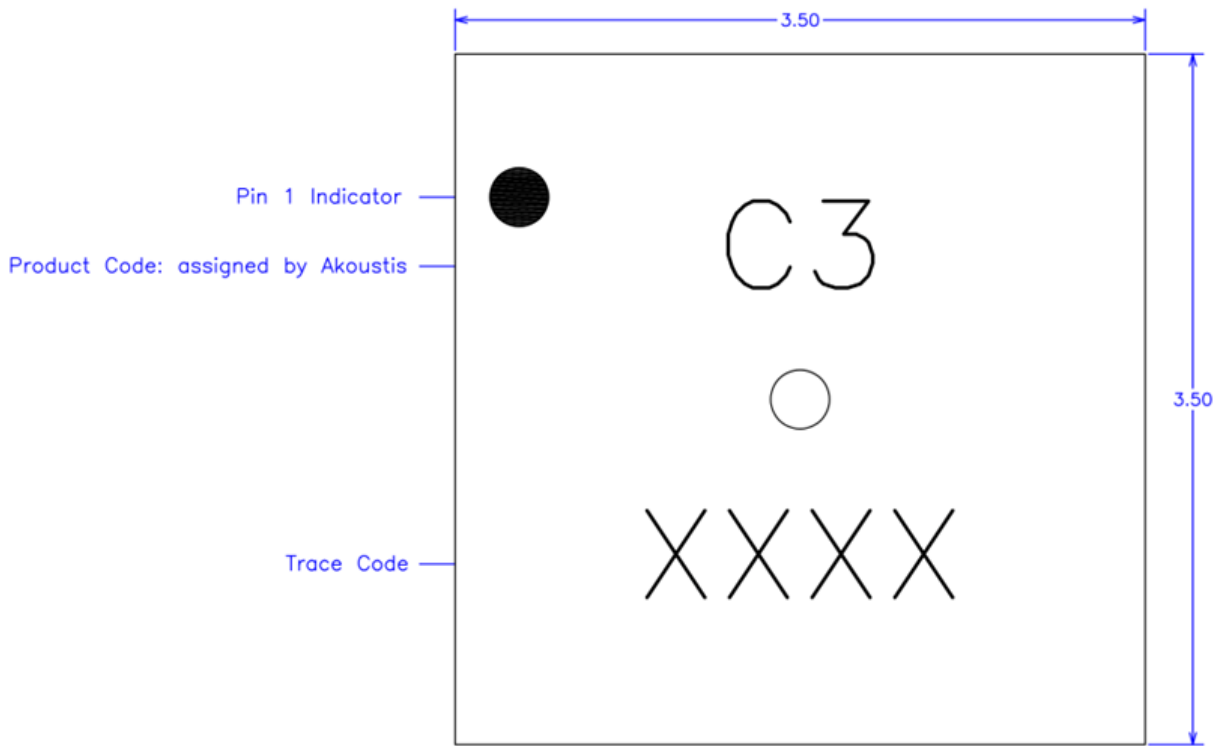

Reel Dimensions

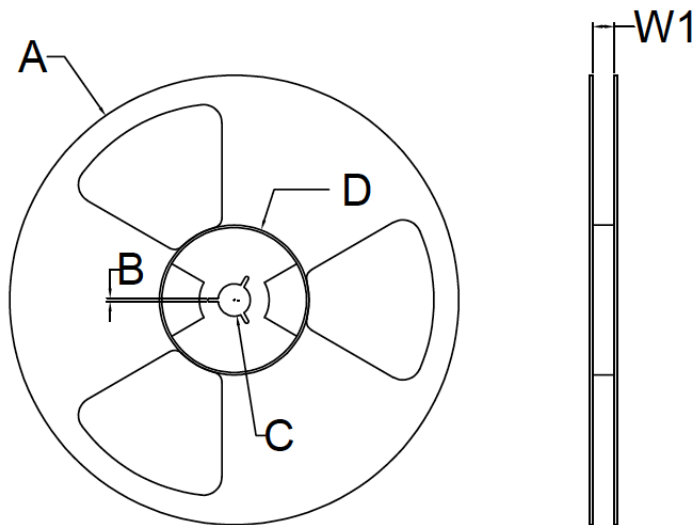

Reel Dimensions						
Reel Size	Tape Width	A	B	C	D	W1 *measured at hub
7 Inch	8 mm	180 +0/-2.0 mm	2.0mm +/-0.5	13.0+0.5/ -0 mm	60.0 +/- 2.0 mm	8.40 +1.5 / -0 mm
	12 mm	180 +0/-2.0 mm	2.0mm +/-0.5	13.0+0.5/ -0 mm	60.0 +/- 2.0 mm	12.40 +2.0 / -0 mm
	16 mm	180 +0/-2.0 mm	2.0mm +/-0.5	13.0+0.5/ -0 mm	60.0 +/- 2.0 mm	16.40 +2.0 / -0 mm
13 Inch	8 mm	330 +/- 2.0 mm	2.0mm +/-0.5	13.0+0.5/ -0.2 mm	102 +/- 2.0 mm	8.8 +2.0 / -0 mm
	12 mm	330 +/- 2.0 mm	2.0mm +/-0.5	13.0+0.5/ -0.2 mm	102 +/- 2.0 mm	12.8 +2.0 / -0 mm
	16 mm	330 +/- 2.0 mm	2.0mm +/-0.5	13.0+0.5/ -0.2 mm	102 +/- 2.0 mm	16.8 +2.0 / -0 mm

Note: 7 Inch Reel Only Has One Opening

Tape Dimension

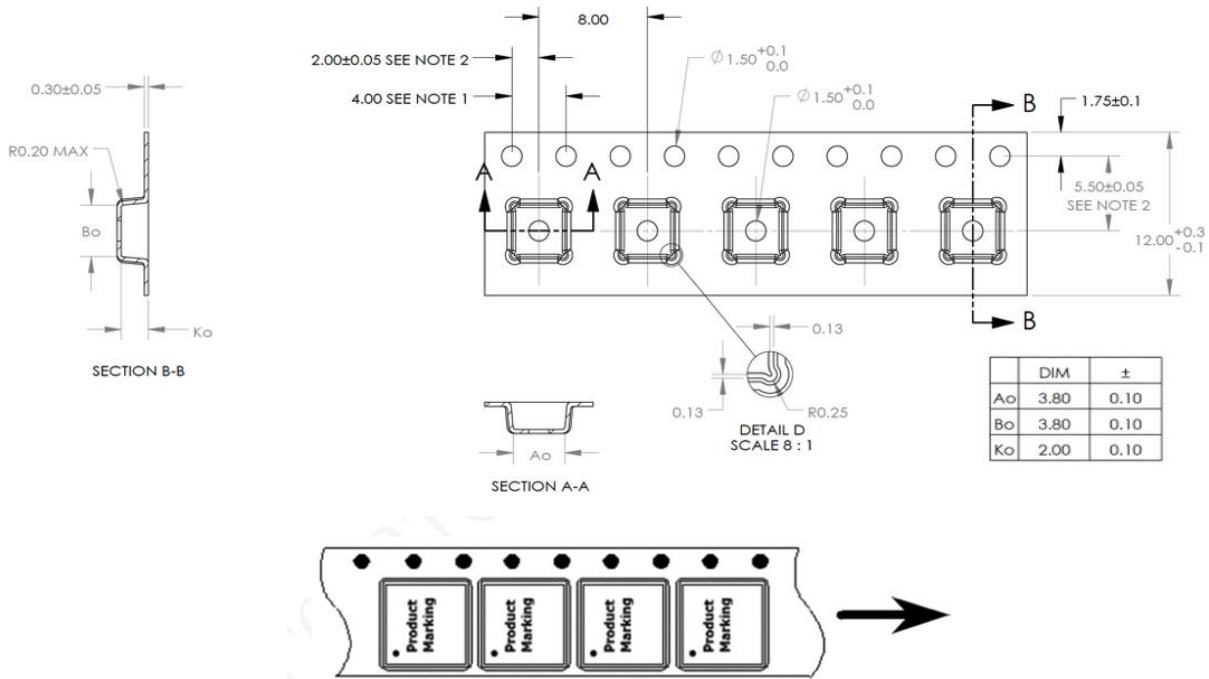

Recommended Solder Profile

Parameter	Eutectic Sn/Pb	Pb Free
Max Ramp Up Rate	6 Deg C/Second	6 Deg C/Second
Soak Temp Time T_S (min) - T_S (max)	135 - 155 Deg C	150-200 Deg C
Max Soak Time T_S	2 minutes	3 minutes
Liquidous Temp T_L	183 Deg C	220 Deg C
Max Time Above T_L	150 Seconds	150 Seconds
Max Peak Temperature T_P	225 Deg C	260 Deg C
Max Time at Peak T_P	30 Seconds	30 Seconds
Max Ramp Down Rate	10 Deg C/Second	10 Deg C/Second

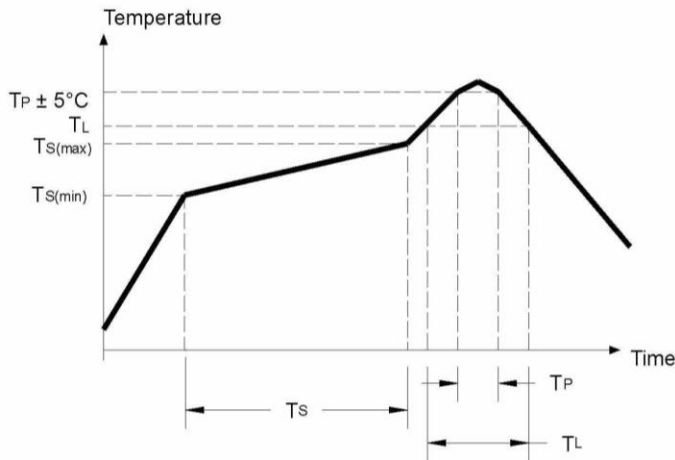

A10266

Product Compliance Information

ESD Sensitivity Ratings

Human Body Model (HBM) Test

Rating: Class 2

Standard: ANSI/ESDA/JEDEC JS-001-2017

Charged Device Model (CDM)

Rating: Class C3

Standard: ANSI/ESDA/JEDEC JS-002-2018

MSL Rating

MSL1

RoHS

This part is compliant with the 2011/65EU RoHS directive on the restrictions of the use of certain hazardous substances in electrical and electronic equipment as amended by Directive (EU) 2015/863

Contact Information

All contents specified in the datasheet are subject to change. Please contact Akoustis for the latest on our products and company information.

Email: sales@akoustis.com

Website: www.akoustis.com

Telephone: +1 704.997.5735

Fax: +1 704.997.5734