

5.5 GHz WiFi 6E Coexistence BAW Filter

A10155

Description

Akoustis’ A10155 is a high-performance, ultra-wide bandwidth BAW RF Filter for use in WiFi 6E applications covering U-NII-1 thru U-NII-3 bands. A10155 utilizes Akoustis’ patented, XBAW™ technology which provides leading RF filter performance. This BAW RF filter provides low insertion loss and meets the stringent rejection requirements enabling coexistence with U-NII-5 thru 8. This device exhibits high-power handling capabilities necessary for demanding power requirements of the latest WiFi 6E standards. A10155 is a fully integrated, 50Ω module using standard laminate packaging and is compatible with high volume, lead-free SMT soldering processes.

- Small form factor 3.5mm x 3.5mm x 1.4mm
- Single-ended Tx/Rx ports.
- Ultra-wide passband covering 665MHz
- High rejection enables coexistence with adjacent WiFi UNII bands
- High power rating, maximum +27dBm
- Low insertion loss bandpass filter
- Performance over -40 C to +85C
- RoHS compliant, Pb-free package

Applications

- WiFi 6E tri band routers, integrated cable modem
- WiFi 6E tri band access points
- LTE/LAA small cells

Functional Block Diagram

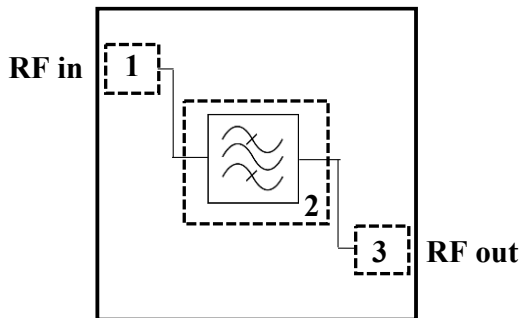

Pin #	Description
1	RF Input
2	Ground
3	RF Output

Ordering Information

Part Number	Description
A10155EVB	Evaluation board
A10155SP	(5) Loose pcs
A10155SR	(100) Short Reel (7" Reel)
A10155TR1	(1000) Tape & Reel (7" Reel)
A10155TR2	(2500) Tape & Reel (13" Reel)

Absolute Maximum Ratings

Parameter	Conditions	Rating
Storage Temperature		-40 to 125 °C
Max Input Power	Signal: OFDM MCS0, 20 MHz, PAR 10dB	+28.5 dBm
Max Temperature		-40 to 105°C

Exceeding any one limit or a combination of AMR conditions may result in damage to the device

Operating Parameters (Temp = -40°C to +85°C unless otherwise noted)

Parameter	Conditions	Units	Min.	Typ.	Max.
Passband		MHz	5170	5502.5	5835
Insertion Loss	5170 – 5815 MHz	dB		1.7 ⁽¹⁾	2.7 ⁽²⁾
	5815 – 5835 MHz	dB		2.8 ⁽¹⁾	2.9 ⁽²⁾
Amplitude Variation	5170 – 5835 MHz	dB		1.7 ⁽²⁾	1.8 ⁽²⁾
Attenuation	30 – 1000 MHz	dB	35	36	
	1000 – 4200 MHz	dB	22	23	
	4200 – 5000 MHz	dB	19	22	
	5945 – 6425 MHz	dB	46 ⁽²⁾	52 ⁽¹⁾	
			47 ⁽³⁾		
	6425 – 6525 MHz	dB	50 ⁽²⁾	52 ⁽¹⁾	
	6525 – 7065 MHz	dB	40 ⁽²⁾	49 ⁽¹⁾	
			41 ⁽³⁾		
7065 – 7125 MHz	dB	37 ⁽²⁾	41 ⁽¹⁾		
7200 – 8000 MHz	dB	4	5		
Return Loss	5170 – 5835 MHz		10	17 ⁽¹⁾	
Load Impedance		Ω		50	
Power Handling:	OFDM MCS0, 20 MHz, PAR 10dB	dBm			27

Note:

1. Averaged over specified frequency at room temperature
2. Averaged over 20MHz channel
3. Averaged over 160MHz channel

EVB Schematic & Layout

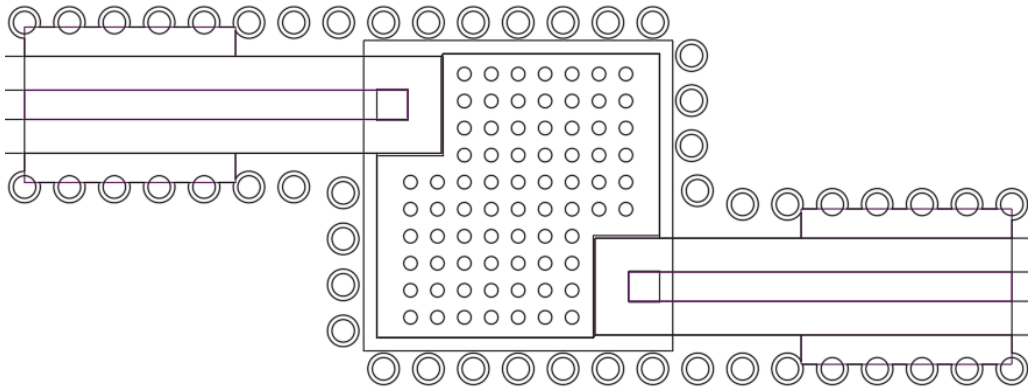
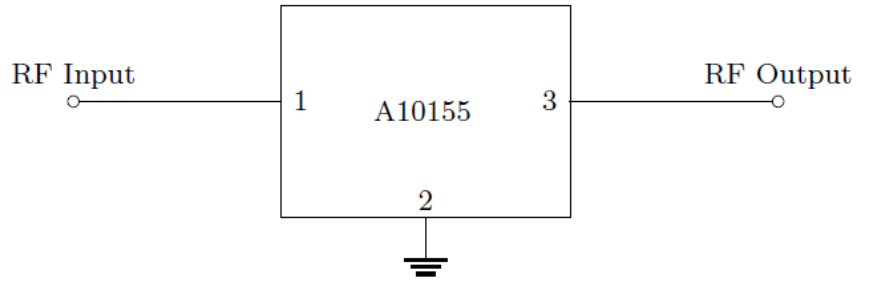
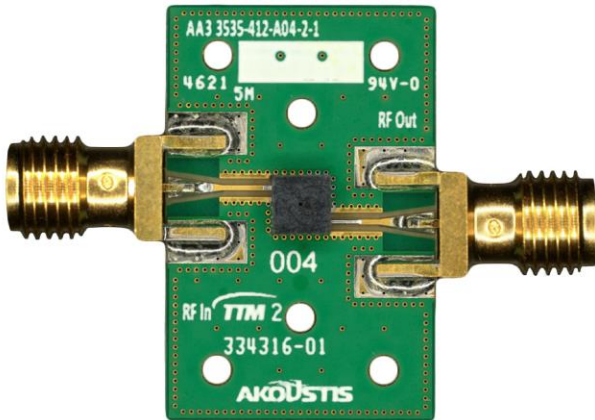

Note:

- 1) Center ground pad vias 6mil diameter
- 2) RF ground vias 10mil diameter

Bill of Materials

Reference Des.	Value	Description	Manufacturer	Part Number
PCB	N/A	4 layer	Multiple	AA33535-412-A04-2-1
U1	N/A	5.5 GHz BAW Filter	Akoustis	A10155

Performance Plots (Temp = 25°C unless otherwise noted)

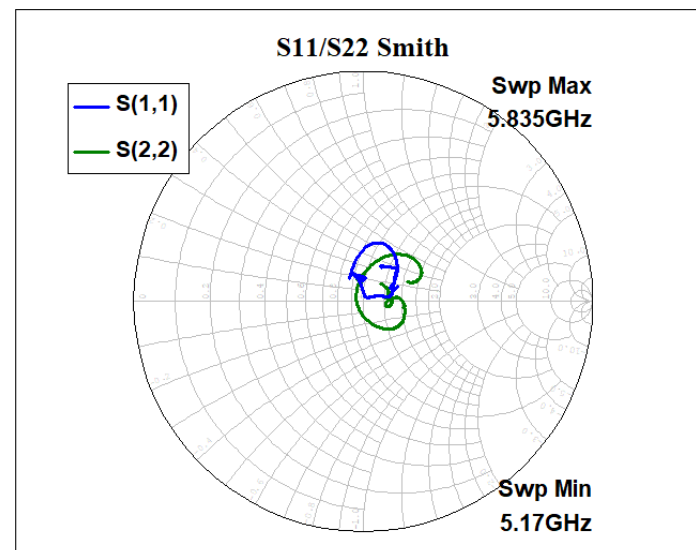
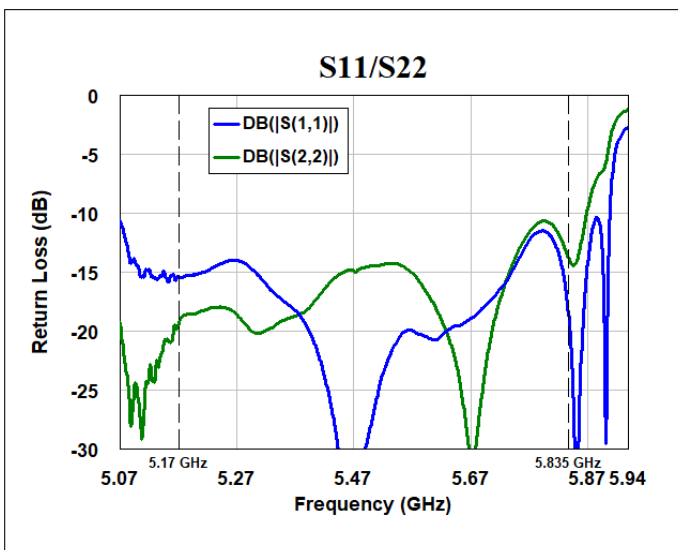
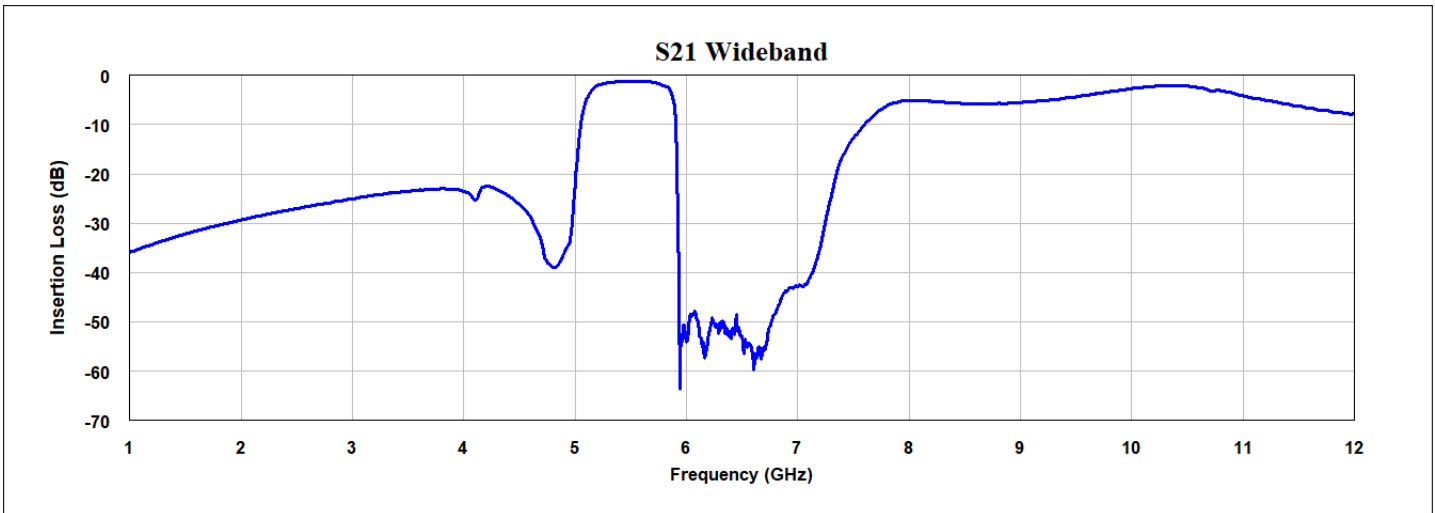
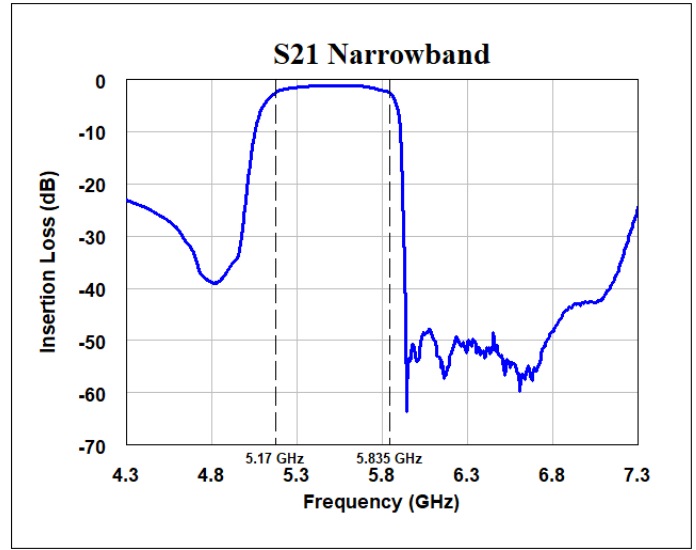
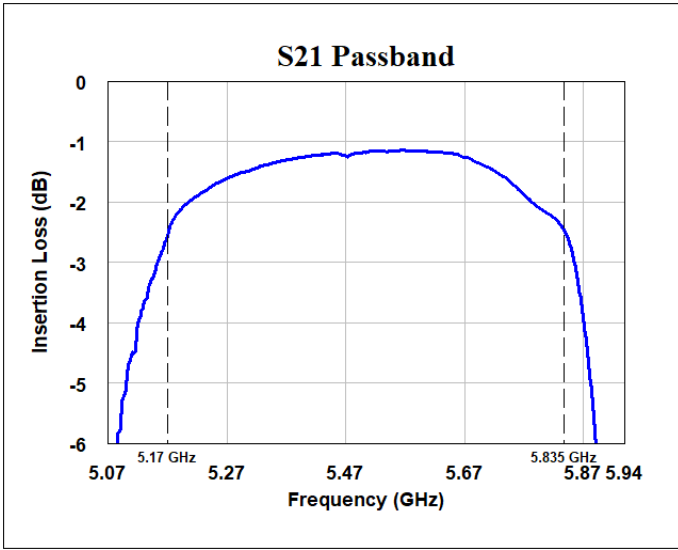

Package Drawing & Pin Description

- Notes:
- All Units are in mm unless otherwise stated
 - General Tolerance:
 Linear X.XXX = $\pm 0.050\text{mm}$
 X.XX = $\pm 0.10\text{mm}$

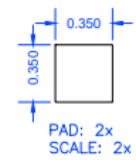
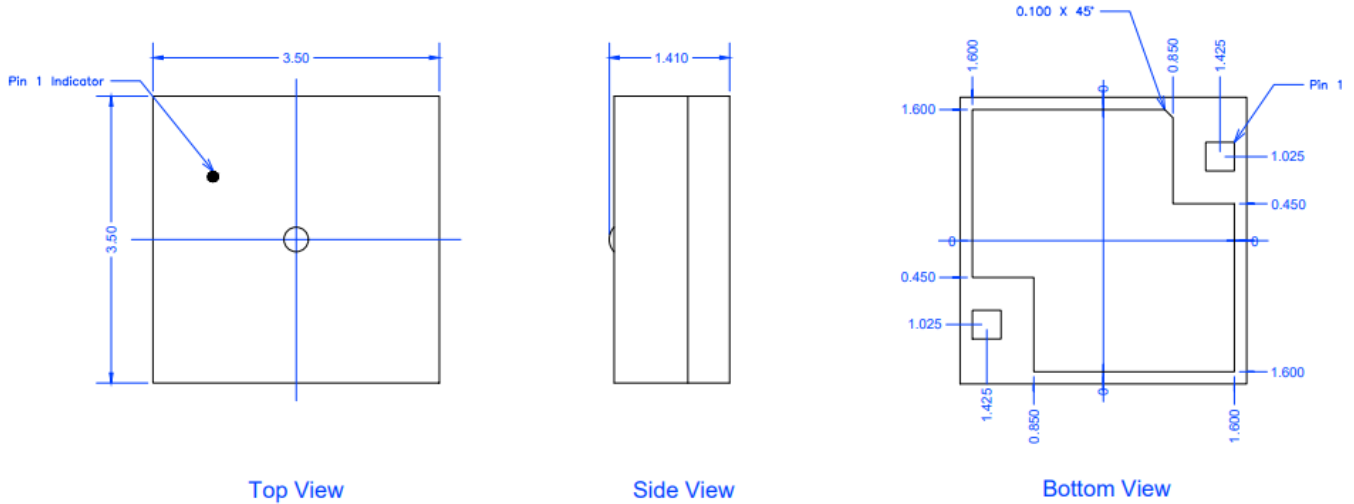

PCB Mounting Pattern

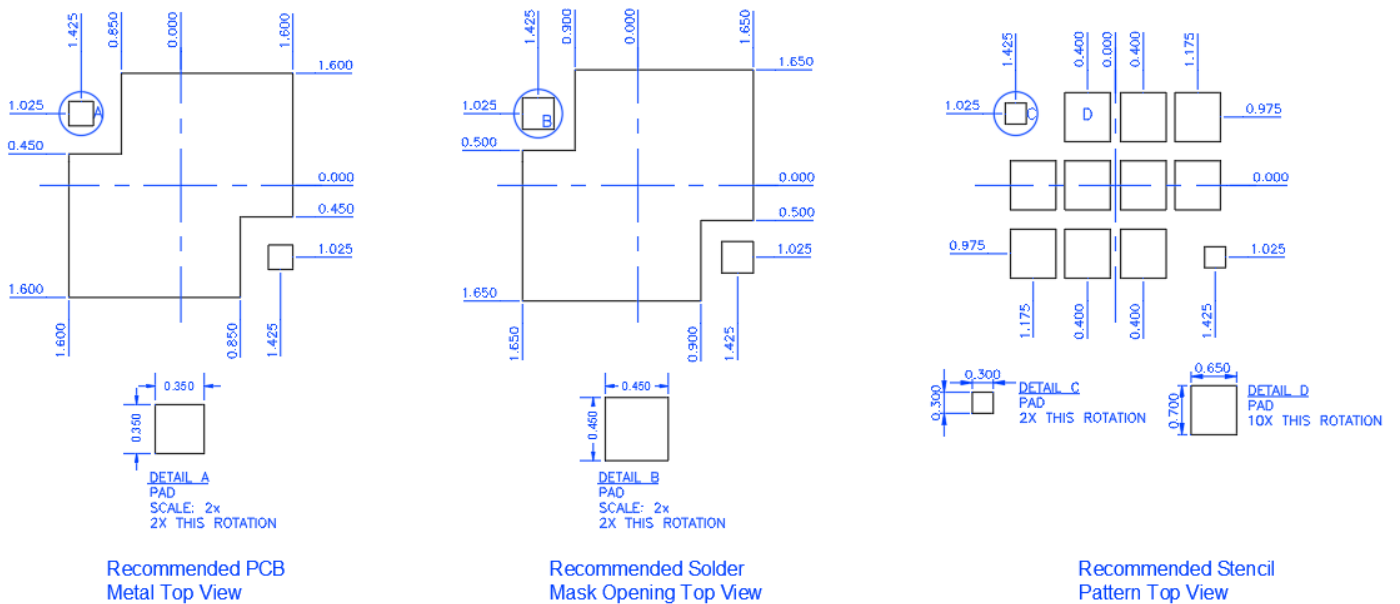

Typical Part Marking

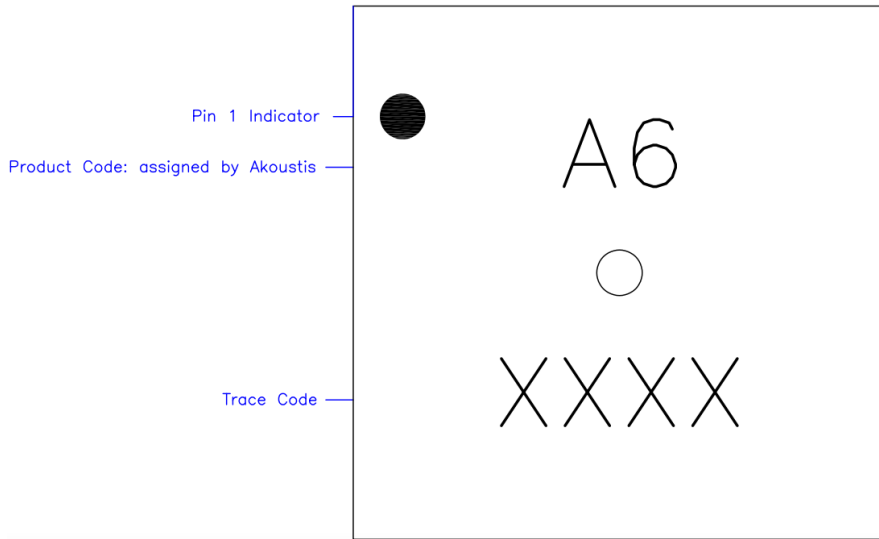

Reel Dimensions

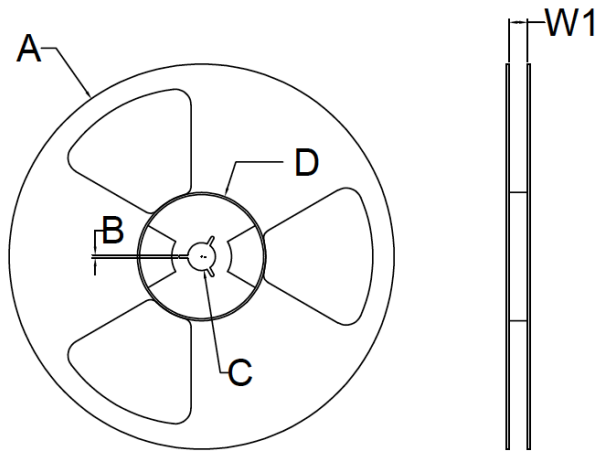

Reel Dimensions						
Reel Size	Tape Width	A	B	C	D	W1 *measured at hub
7 Inch	8 mm	180 +0/-2.0 mm	2.0mm +/-0.5	13.0 + 0.5 / -0 mm	60.0 +/- 2.0 mm	8.40 + 1.5 / -0 mm
	12 mm	180 +0/-2.0 mm	2.0mm +/-0.5	13.0 + 0.5 / -0 mm	60.0 +/- 2.0 mm	12.40 + 2.0 / -0 mm
	16 mm	180 +0/-2.0 mm	2.0mm +/-0.5	13.0 + 0.5 / -0 mm	60.0 +/- 2.0 mm	16.40 + 2.0 / -0 mm
13 Inch	8 mm	330 +/- 2.0 mm	2.0mm +/-0.5	13.0 + 0.5 / -0.2 mm	102 +/- 2.0 mm	8.8 + 2.0 / -0 mm
	12 mm	330 +/- 2.0 mm	2.0mm +/-0.5	13.0 + 0.5 / -0.2 mm	102 +/- 2.0 mm	12.8 + 2.0 / -0 mm
	16 mm	330 +/- 2.0 mm	2.0mm +/-0.5	13.0 + 0.5 / -0.2 mm	102 +/- 2.0 mm	16.8 + 2.0 / -0 mm

Note: 7 Inch Reel Only Has One Opening

Tape Dimension

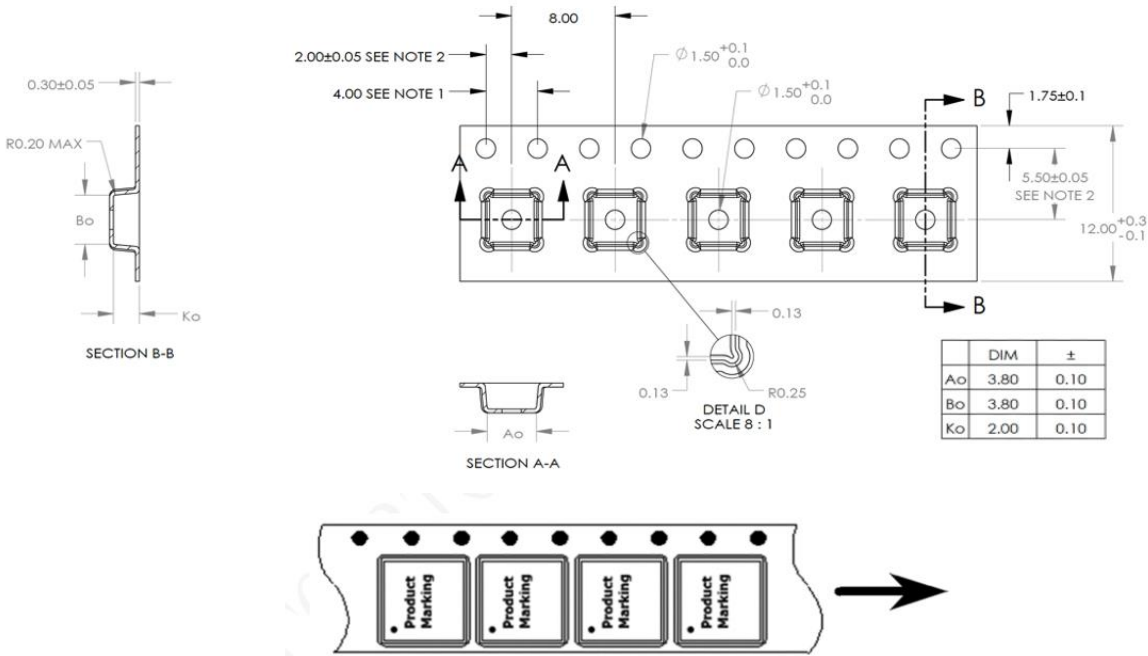

Recommended Solder Profile

Parameter	Eutectic Sn/Pb	Pb Free
Max Ramp Up Rate	6 Deg C/Second	6 Deg C/Second
Soak Temp Time $T_S(\text{min}) - T_S(\text{max})$	135 - 155 Deg C	150-200 Deg C
Max Soak Time T_S	2 minutes	3 minutes
Liquidous Temp T_L	183 Deg C	220 Deg C
Max Time Above T_L	150 Seconds	150 Seconds
Max Peak Temperature T_P	225 Deg C	260 Deg C
Max Time at Peak T_P	30 Seconds	30 Seconds
Max Ramp Down Rate	10 Deg C/Second	10 Deg C/Second

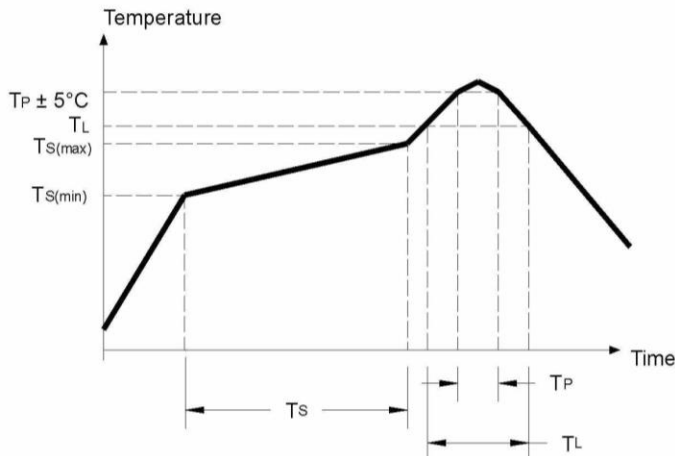

A10155

Product Compliance Information

ESD Sensitivity Ratings

Human Body Model (HBM) Test

Rating: Class 1B 500V

Standard: ANSI/ESDA/JEDEC JS-001-2017

Charged Device Model (CDM)

Rating: Class C3 1000V

Standard: ANSI/ESDA/JEDEC JS-002-2018

MSL Rating

MSL1

RoHS

This part is compliant with the 2011/65EU RoHS directive on the restrictions of the use of certain hazardous substances in electrical and electronic equipment as amended by Directive (EU) 2015/863

Contact Information

All contents specified in the datasheet are subject to change. Please contact Akoustis for the latest on our products and company information.

Email: sales@akoustis.com

Website: www.akoustis.com

Telephone: +1 704.997.5735

Fax: +1 704.997.5734